



REX-P250



General Description

The REX-P250 is a high performance ramp/soak controller with a storage capacity of 256 segments in 16 patterns. Each pattern consists of up to 16 segments and patterns can be linked for maximum pattern storage. This instrument can store up to 8 PID memory areas and 8 alarm memory areas so the most suitable PID parameters and alarm settings can be selected for each segment. The REX-P250 has a unique front panel with a program pattern card to simplify program pattern checking. There is also an audible verification of key operation. Standard features include a wide range of inputs and outputs such as digital inputs for control status change between Reset, Run, Hold and Step, pattern end output, external contact input and control outputs.

Optional features include dual alarms, analog retransmission output, heater break alarm, digital communication and position proportional control action.

Features

- ☆ Multi-memory area
- ☆ Autotuning learning function
- ☆ Digital communications
- ☆ Three control modes
- ☆ Time signal outputs
- ☆ External contact input

At-a-Glance Monitoring

The program pattern number and segment under execution can be monitored from the front panel. The program's progress can be more easily followed if a program pattern card is used. This allows the operator to draw the time and temperature profile to see in real-time where the LED's traverse along the program.

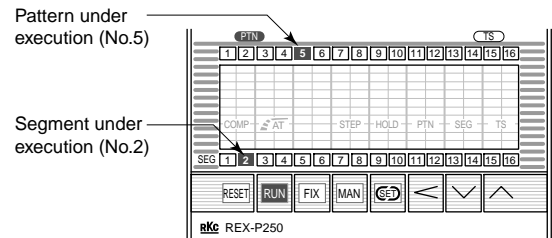

Multi-Memory Area

The REX-P250 ramp/soak controller's PID and alarm memory areas are independent so that you can select the most suitable one for each segment.

Each of the 8 PID memory areas can store PID parameters, output limit High, output limit Low, deadband for position proportional control and differential gap for ON/OFF control. The 8 alarm memory areas can store ALM1, ALM2 and heater break alarm set values.

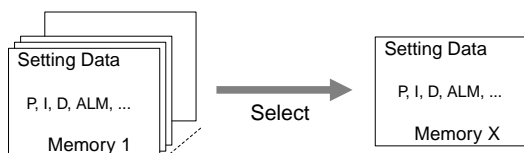

Three Control Modes

The control mode can be easily changed to either ramp/soak, fixed set point or manual mode.

1. Ramp/Soak control mode
2. Fixed set point control mode
3. Manual control mode

Autotuning Learning Function

The PID values obtained may not be ideal for all set points within a given program. The use of the autotuning learning function (AT) allows a maximum of eight optimum PID values to be obtained automatically for use in the program.

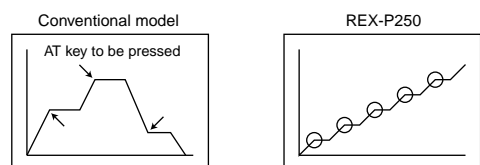

AT key to be pressed at each level (shown according to program progress)

Autotuning is executed automatically at each soak level without executing program.

Ramp/Soak Temperature Controller REX-P250

Features

16 Patterns with 16 Segments

A maximum of 16 patterns with 16 segments per pattern can be stored in memory. Each pattern can be linked together so that it is possible to have a program with a maximum of 256 segments.

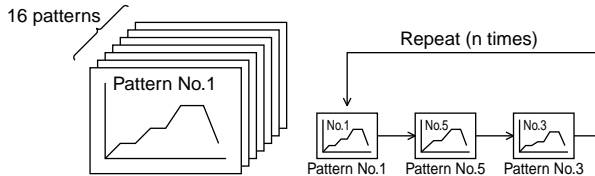

Time Signal Output

The ON/OFF time signal function can be set for each output so that Heat/Cool time signals can be sent to auxiliary equipment. There is a maximum of 16 settings per pattern.

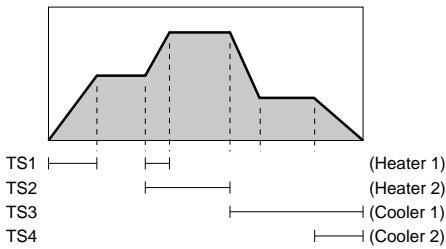

Digital Input

Control status can be changed between Reset, Run, Hold and Step with digital inputs. A pattern number can also be set with digital inputs.

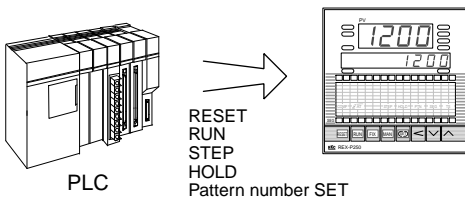

Analog Retransmission Output (Optional)

The analog retransmission output function is available for use with auxiliary equipment such as a recorder or data logger. Either the process, set, or manipulated value can be produced in DC voltage or current.

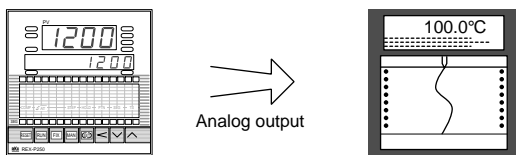

Digital Communications (Optional)

An optional communications interface, RS-232C or RS-422A, is available for networking to computers, PLCs and SCADA software. Up to 31 units can be interfaced on one RS-422A communication line.

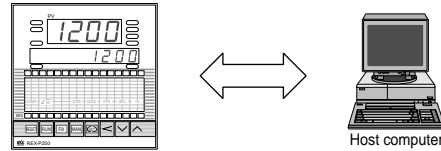

PV Start

If a PV (measured value) is at a certain level when program control is started, the program start level can be specified to the present PV level.

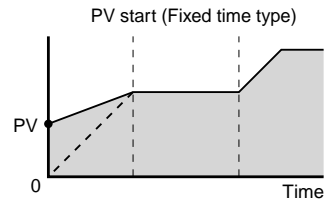

Valve Motor Control

This instrument provides valve motor control feedback resistance for position proportional control.

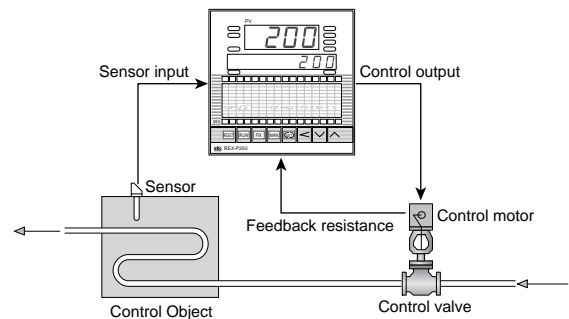

Heater Break Alarm (Optional)

The heater break alarm (HBA) function monitors the load via an external current transformer and detects failures in the control circuit such as heater breaks and the failure of a mechanical or solid state relay. When the control output is on and the load current drops below the HBA set value, the heater break alarm is activated. Conversely, when the control output is off and the load current still exists, the heater break alarm is turned on.

•Current transformer : CTL-6-P-N (0 to 30A), CTL-12-S56-10L-N (0 to 100A)

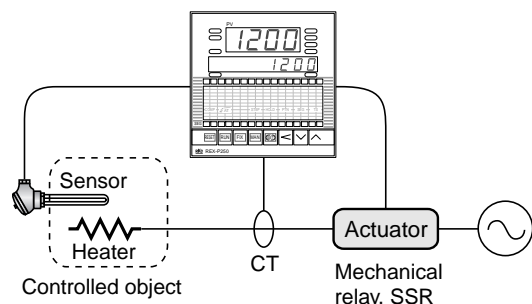

Ramp/Soak Temperature Controller REX-P250

Specifications

Input

Input

- a) Thermocouple : K, J, R, S, B, E, T, N (JIS/IEC), PLII (NBS)
W5Re/W26Re (ASTM), L (DIN)
• Influence of external resistance : Approx. $0.35\mu\text{V}/\Omega$
• Input break action : Up-scale
- b) RTD : Pt100 (JIS/IEC), JPt100 (JIS)
• Influence of input lead resistance : Approx. 10Ω or less
• Input break action : Up-scale
- c) DC voltage input : 0 to 10mV, 0 to 100mV, 0 to 1V, 0 to 5V, 1 to 5V, 0 to 10V
• Input break action : Uncertain (Down-scale for 1 to 5V DC)
- d) DC current input : 0 to 20mA, 4 to 20mA
• Input break action : Uncertain (Down-scale for 4 to 20mA)

Sampling Time

0.5 sec

PV Bias

-Span to +Span (However, between -1999 and 9999)

Performance

Measuring Accuracy

Thermocouple

- $\pm(0.3\%$ of reading + 1 digit) or $\pm 2^\circ\text{C}$ (4°F), whichever is larger
• R, S and B input accuracy is not guaranteed between 0 and 399°C (0 and 750°F)

RTD

- $\pm(0.3\%$ of reading + 1 digit) or $\pm 0.8^\circ\text{C}$ (1.6°F), whichever is larger

DC voltage, DC current

- $\pm(0.2\%$ of reading + 1 digit)

Segment Time Accuracy

$\pm(0.01\%$ of set value) or $\pm 50\text{msec}$, whichever is larger

Insulation resistance

More than $20\text{M}\Omega$ (500V DC) between measured and ground terminals
More than $20\text{M}\Omega$ (500V DC) between power and ground terminals

Dielectric Strength

1000V AC for one minute between measured and ground terminals
1500V AC for one minute between power and ground terminals

Program

Storage Program Pattern : Max. 16 patterns (16 segments per pattern)

Storage Segments : Max. 256 segments when linking 16 patterns of 16 segments each.

Program Repeat : 1 - 999 times or continuous

Level Setting : See Input Range Code Table

Time Setting : 00 hr 00 min 00 sec to 99 hrs 59 min 59 sec

PID Constant Section : Selectable from 8 patterns for each segment

Start Mode : Zero start or PV start (selectable)

Wait zone : Up/down 0 to 99°C ($^\circ\text{F}$) or 0.0 to 9.9°C ($^\circ\text{F}$)

Control

Control Method

- a) ON/OFF control
b) PID control
c) PID control with autotuning
d) Position proportioning control

Memory Area : 8 areas for PID constant section.

Major Setting Range

Setting range : Same as input range.
Proportional band : 0.1 to 999.9% of span (ON/OFF action when P=0)
Integral time : 1 to 3600sec.(P + D action when I=0)
Derivative time : 1 to 3600sec.(P + I action when D=0)
Differential gap : 0 to 100°C ($^\circ\text{F}$) or 0.0 to 100.0°C ($^\circ\text{F}$)
(When used with ON/OFF action)
Output limiter High : -5.0 to +105.0%
Output limiter Low : -5.0 to +105.0%

Control Output

Relay output : Form C contact, 250V AC 3A (resistive load)
Voltage pulse output : 0/12V DC
(Load resistance : More than 800Ω)
Current output : 0 to 20mA or 4 to 20mA DC
(Load resistance : Less than 600Ω)
Continuous voltage output : 0 to 5V, 0 to 10V, 1 to 5V DC
(Load resistance : More than $1\text{k}\Omega$)
Triac trigger output : Trigger method, Zero-cross method
(resistive load) (100A or less)

Valve Motor Control (Position proportioning type only)

Input resistance (Feedback resistance) : 135Ω as standard.
POS sampling time : 1 sec.
Neutral band : 0.1 to 20.0% of proportional band
Output : Relay output, 250V AC 3A (resistive load)
Form A contact for OPEN and CLOSE.
Motor rotating speed : Suitable for 20 to 240 sec. (Full open to full close)

Standard Functions

Time Signal

Setting time : 00 hr 00 min 00 sec to 99 hrs 59 min 59 sec.
Storage pattern : 16 patterns (16 times ON/OFF per pattern)
Output : 4 points, open collector output, 24V DC 50mA

Pattern End Output

Setting time : 00 hr 00 min 00 sec to 99 hrs 59 min 59 sec.
Output : 1 point, open collector output, 24V DC 50mA

External Control

Start pattern No. setting (4-bit binary contact), RESET, RUN, HOLD, STEP

Alarms

(Optional)

Temperature Alarm

- a) Number of alarms : 2 points
b) Alarm action : Deviation High, Low, High/Low, Band, and Process High, Low alarms
c) Alarm differential gap : 0 to 100°C ($^\circ\text{F}$)(%) or 0.0 to 100.0°C ($^\circ\text{F}$)(%)

Heater Break Alarm (For single phase)

Setting : 0.0 to 100.0A
CT type : CTL-6-P-N (30A)
CTL-12-S56-10L-N (100A)

- When heater break alarm (HBA) function is used, Alarm 2 is not available.
- When control output type is current output or continuous voltage, heater break alarm is not available.

Alarm Output

Relay output, Form A contact 250V AC 1A (resistive load)

Options

Retransmission Output

Number of outputs : 1 point
Output signal : 0 to 10mV, 0 to 100mV DC
(Load resistance : More than $20\text{k}\Omega$)
0 to 1V, 0 to 5V, 0 to 10V, 1 to 5V DC
(Load resistance : More than $1\text{k}\Omega$)
0 to 20mA, 4 to 20mA DC
(Load resistance : Less than 600Ω)
Output type : Measured value (PV), Set value (SV), Manipulated output (MV)

Digital Communications

- a) Communication method : RS-422A (2-wire), RS-232C
b) Communication speed : 600, 1200, 2400, 4800, 9600 bps
c) Bit format
Start bit : 1
Data bit : 7 or 8
Parity bit : Without, even or odd
Stop bit : 1 or 2
d) Communication code : ASCII(JIS) 7-bit code

Ramp/Soak Temperature Controller **REX-P250**

General Specifications

Self-Diagnostic Function

Setting input data check, RAM check, CPU power check and watchdog timer.
Fail output : 1 point relay contact output 250V DC 0.1A (Resistive load)
OPEN when fail is detected.

Supply Voltage

90 to 264V AC (Including supply voltage variation)
[Rating : 100 to 240V AC] (50/60Hz common)

Power Consumption

Less than 15VA (100 to 240V AC)

Power Failure Effect

If a power failure of more than 50 ms and less than 4 sec occurs, controller will take HOT start as restart conditions.
Select HOT or COLD start for restart conditions after a power failure of more than 4 sec.

Operating Environments : 0 to 50°C [32 to 122°F] , 45 to 85% RH

Memory Backup : RAM back-up by lithium battery

Net Weight

Approx. 750g

External Dimensions (W x H x D)

96 x 96 x 150mm

Compliance with Standards (Optional)

- CE Mark
- UL Recognized
- CSA Certified



- Triac trigger output type and triac output are not CE Mark, UL Recognized or CSA Certified.

CVM-4 Output Converter (Optional)

CVM-4 converts the output types of **4-point** time signal output and a pattern end output from open collector to relay output.

Input

Open collector output from REX-P250 (parallel signal)

Output

Time signal output 4 points
Pattern end output 1 point
Relay output, Form A contact 250V AC 2A (resistive load)

Cable Length

2 meters (The cable shall be prepared separately.)

Supply Voltage

100/110V, 120V, 200/220V, 240V AC $\pm 10\%$ (50/60Hz)
•Please specify when ordering.

Power Consumption

Less than 6VA

Operating Environments

0 to 50°C [32 to 122°F] , 45 to 85% RH

Net Weight

Approx. 1.5kg

External Dimensions (W x H x D)

67 x 137 x 184mm

SP-1 Selector (Optional)

SP-1-16Y is a pattern number selector which can be connected to REX-P250.

Setting

Digital switch (2-button type), Push switch (Non-lock type)

Setting range

1 to 16

Performance

Contact resistance : Less than 200m Ω

Operating Environments

-10 to 50°C [14 to 122°F] (No dew condensation)

Net Weight

Approx. 110g

External Dimensions (W x H x D)

48 x 48 x 100mm

Ramp/Soak Temperature Controller REX-P250



Model and Suffix Code

Specifications	Model and Suffix Code										
Model	REX-P250 (1/4 DIN size) <input type="checkbox"/> <input type="checkbox"/> <input type="checkbox"/> - <input type="checkbox"/> * <input type="checkbox"/> - <input type="checkbox"/> <input type="checkbox"/> - <input type="checkbox"/>										
Control method	PID control PID control with AT Position proportional PID			H							
Alarms	No alarm One alarm Two alarms			N	S	D					
Input type	Thermocouple RTD DC mA, mV, V (Code number 1-8)			C	R						
Control output	Relay output Voltage pulse DC current (See Output Table) DC voltage (See Output Table) Triac trigger			M	V	R	E	G			
Case color	Black								B		
Heater break alarm (HBA)	Not supplied 1-phase heater break alarm								N	2	
Analog output	Not supplied DC mA, mV, V (Code number 1-8)								N		<input type="checkbox"/>
Digital communications	Not supplied RS-232C RS-422A (4-wire system)								N	1	2

• For CE Mark, UL Approved and CSA Certified products, add the suffix of "CE" to the end of the model code.

Alarm Action Type

Deviation High	Deviation Low	Deviation High/Low
Band Alarm	Deviation High with alarm Hold	Deviation Low with alarm Hold
Deviation High/Low with alarm Hold	Band Alarm with alarm Hold	Process High
Process Low	Process High with alarm Hold	Process Low with alarm Hold

- Specify alarm type when ordering.
- When two alarms are selected, heater break alarm is not available.

Range and Input Table

Thermocouple (Field-programmable)

Input	Range
K	0 - 200°C
	0 - 400°C
	0 - 600°C
	0 - 800°C
	0 - 1000°C
	0 - 1200°C
	0 - 1372°C
	-100.0 - 400.0°C
	0 - 800°F
	0 - 1600°F
0 - 2502°F	
-100.0 - 750.0°F	
J	0 - 200°C
	0 - 400°C
	0 - 600°C
	0 - 800°C
	0 - 1000°C
	0 - 1200°C
	-100.0 - 400.0°C
	0 - 800°F
	0 - 1600°F
	0 - 2192°F
-100.0 - 750.0°F	

Input	Range
R ¹	0 - 1600°C
	0 - 1769°C
	0 - 3200°F
S ¹	0 - 3216°F
	0 - 1600°C
	0 - 1769°C
B ¹	0 - 3200°F
	0 - 3216°F
	400 - 1800°C
E	0 - 1820°C
	750 - 3200°F
	0 - 3308°F
	0 - 800°C
	0 - 1000°C
-100.0 - 300.0°C	
0 - 1600°F	
0 - 1832°F	
-100.0 - 500.0°F	

Input	Range
T	0 - 400°C
	0 - 752°F
	-199.9 - 400.0°C
	-199.9 - 100.0°C
	-100.0 - 200.0°C
	0.0 - 350.0°C
	-199.9 - 752.0°F
	-100.0 - 200.0°F
	-100.0 - 400.0°F
	0.0 - 752.0°F
N	0 - 1200°C
	0 - 1300°C
W5Re / W26Re	0 - 2300°F
	0 - 4000°F
PLII	0 - 1300°C
	0 - 2300°F
L	0 - 400°C
	0 - 800°C
	0 - 800°F
	0 - 1600°F

RTD (Field-programmable)

Input	Range
Pt100 JPt100	-199.9 - 649.0°C
	-199.9 - 200.0°C
	-100.0 - 50.0°C
	-100.0 - 100.0°C
	-100.0 - 200.0°C
	0.0 - 50.0°C
	0.0 - 100.0°C
	0.0 - 200.0°C
	0.0 - 300.0°C
	0.0 - 500.0°C
	-199.9 - 999.9°F
	-199.9 - 400.0°F
	-199.9 - 200.0°F
	-100.0 - 100.0°F
	-100.0 - 300.0°F
	0.0 - 100.0°F
0.0 - 200.0°F	
0.0 - 400.0°F	
0.0 - 500.0°F	

- Specify a input type and range when ordering.
- ¹ Type R, S and B input : Accuracy is not guaranteed between 0 to 399°C (0 to 750°F).

Signal Code Table

1	0 - 10mV DC	2	0 - 100mV DC	3	0 - 1V DC	4	0 - 5V DC
5	0 - 10V DC	6	1 - 5V DC	7	0 - 20mA DC	8	4 - 20mA DC

Output Table

R	Current output	4 - 20mA DC	0 - 20mA DC	
E	Continuous voltage output	0 - 5V DC	0 - 10V DC	1 - 5V DC

Ramp/Soak Temperature Controller **REX-P250**

Model and Suffix Code

CVM-4 Output Converter

CVM-4 converts the output types of **4-point** time signal output and a pattern end output from open collector to relay output.

Specifications	Model and Suffix Code		
Model	CVM-4	- 2	<input type="checkbox"/>
Contact output	With contact output (Without FAIL output)	2	
Supply voltage	100 / 110V AC		1
	120V AC		2
	200 / 220V AC		3
	240V AC		4
	Other		9

•REX-P250 connection cable is to be prepared by customers.

SP-1 Pattern Number Selector

The SP-1 is a pattern number selector for the REX-P250 in connection with the optional contact inputs for pattern set. It simplifies pattern selecting operation by plant floor personnel. On the SP-1, as soon as P SET button is pressed after a pattern is selected between 1 and 16, the selected pattern will be set on the REX-P250.

Model Code : **SP-1-16Y** (Pattern setting button provided)
SP-1-16N (Pattern setting button not provided)

Ramp/Soak Temperature Controller REX-P250

External Dimensions and Rear Terminals

REX-P250

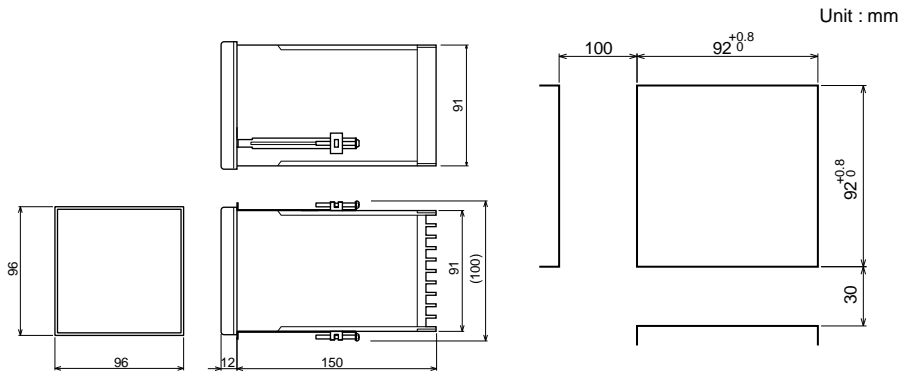
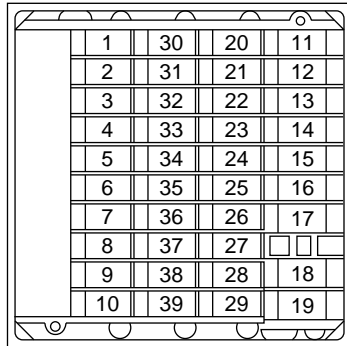

No.	Description
1	Ground
2	AC 100 to 240V
3	
4	COM
5	TS1
6	TS2
7	TS3
8	TS4
9	END
10	

No.	Description
30	Alarm output
31	FAIL
32	ALM1
33	ALM2 or HBA
34	
35	Control output (1) Relay contact output (2) Voltage DC/Current DC (3) Triac trigger output
36	
37	
34*	Control output (Y type)
35	
36	Relay contact output OUT2 : Close side OUT1 : Open side
37	
38	AO ₊
39	

No.	Description
20	COM
21	PTN 1
22	PTN 2
23	PTN 4
24	PTN 8
25	P.SET
26	RESET
27	RUN
28	STEP
29	HOLD

No.	Description
11	SG ⁽¹⁾ SG ⁽²⁾
12	T/R(A) SD
13	T/R(B) RD
14	
15	CT
16	
14*	
15	
16	
17	
18	
19	

* Terminal number Bold Font is motor valve control type (Y type).

* Terminal number Bold Font is motor valve control type (Y type).

CVM-4

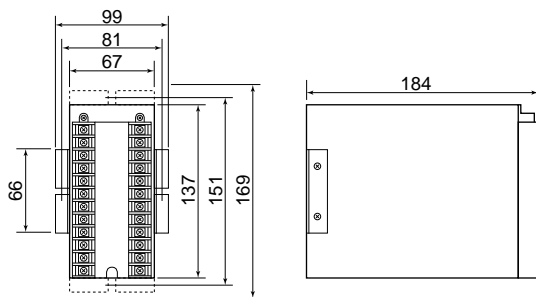

Mounting dimensions

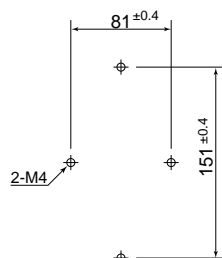

No.	Description
1	G
2	100/110V or 200/220V AC
3	
4	
5	END
6	
7	TS1
8	TS2
9	TS3
10	TS4
11	COM
12	

No.	Description
13	END
14	
15	
16	
17	TS 1
18	TS 2
19	TS 3
20	TS 4
21	
22	
23	
24	

Ramp/Soak Temperature Controller REX-P250

External Dimensions and Rear Terminals

SP-1-16

Unit : mm

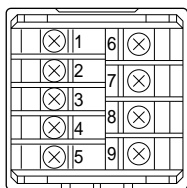
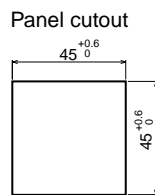
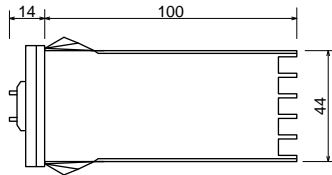
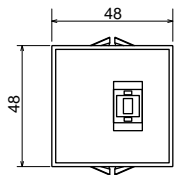

No.	Description
6	P SET
1	CAM
2	1
3	2
4	4
5	8
	Pattern set output
	Binary contact signal