



FB900 FB400



General Description

The FB Series is a high performance process controller with a more advanced Brilliant II PID, autotuning, selectable sampling cycle time of 0.05/0.1/0.25 second and 0.1% of accuracy in short depth housing.

Applications include various plastic machines (extrudes, injection machine, etc), electric furnaces, semiconductor, food processing, environmental chambers and many others.

Features

- ☆ High Accuracy with selectable sampling cycle time
- ☆ The depth of 60mm
- ☆ Inter-controller Communication
- ☆ Brilliant II PID control
- ☆ Start-up tuning and Autotuning

Panel space saving : 60mm depth

The FB Series has very short depth as a 1/8 or 1/4 DIN size controller. The series was designed with a mounting bracket that allows close horizontal mounting of as many as six units.

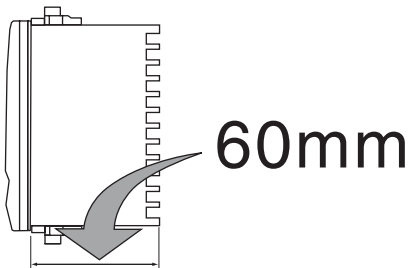

Easy maintenance

The internal assembly of the FB Series can be removed from the front.

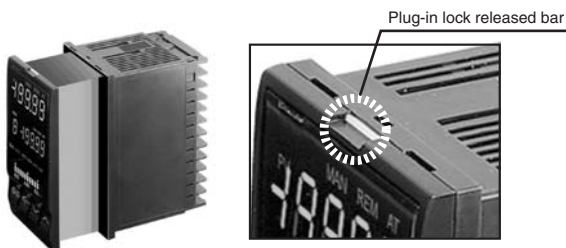

Numerous inputs and outputs

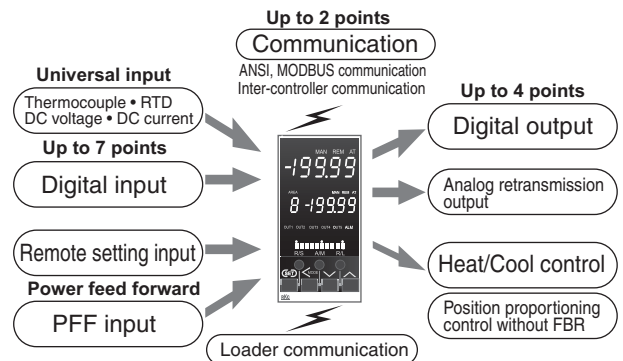

Direct Function Keys

Three direct function keys enable one-touch operation on frequently used functions such as Auto/Manual, Monitoring display scroll, and Memory area selection.

The keys can also be configured as RUN/STOP, Remote/Local, and Auto/Manual keys.

1. Auto/Manual, Monitoring display scroll, Memory area selection

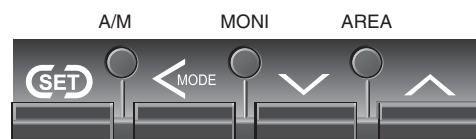

2. Auto/Manual, Remote/Local, RUN/STOP

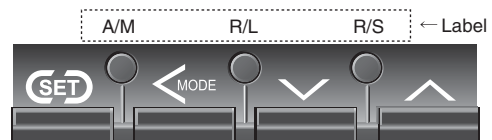

* Also possible to invalidate the direct mode selection key function.

Features

Ramp / Soak Program Control

The FB900/400 Series temperature controller has Recipe (Multi-memory Area) function which stores up to 8 sets of control parameters.

1	Set value	Control response
2	Event 1 to 4 Set Value	Overlap/Deadband
3	Proportional band	Manual reset
4	(Heat and Cool)	Ramp-to-setpoint
5	Integral time	(Up and Down)
6	(Heat and Cool)	LBA time Set value
7	Derivative time	Area soak time
8	(Heat and Cool)	Link area number
	Link area number	

Up to 16-segment ramp/soak control is available by using the memory area function (ramp-to-set point UP and DOWN, soak time, link area number).

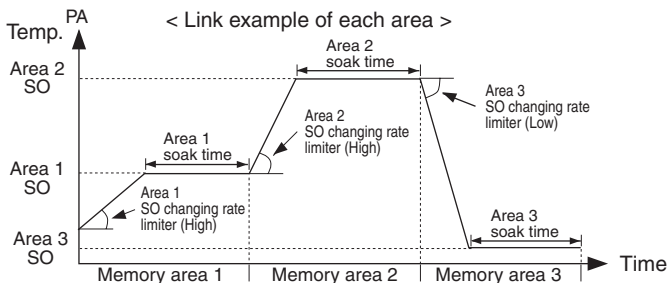

Numerous Inputs and Outputs

A maximum of seven event inputs can be specified. A maximum of five outputs can be specified, and various output functions (control output, analog retransmission, event up to 4) can be allocated in output logic operation.

- Available inputs and outputs depend on the specifications.

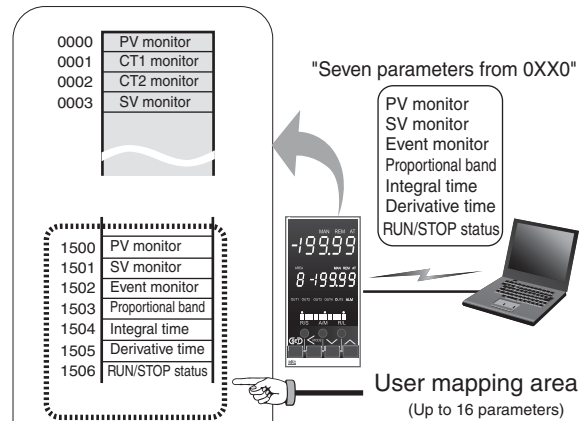

Inter-controller Communication

The FB Series has a second communication port (COM2) for inter-controller communication. It achieves more precise cascade control and ratio control by sending data via digital communication while conventional cascade controllers send data to slave controllers by analog signal with less resolution.

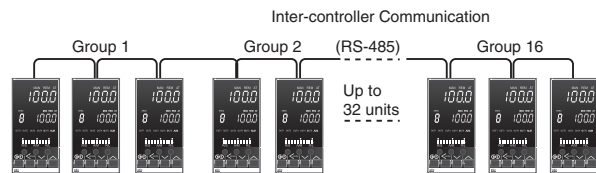

Auto-temperature-rise with Learning Function

Auto-temperature-rise with learning function achieves temperature uniformity at ramp-up without partial thermal expansion even when using multiple FB Series controllers.

- Up to 32 controllers with 16 groups can be configured.
- Auto-temperature-rise function is not available with Heat/Cool PID control toe.

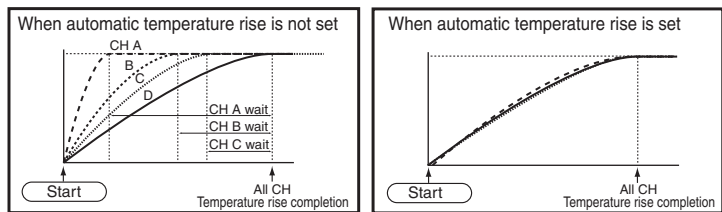

Temperature Ratio Setting

If the master controller changes the control set value, the slave controllers will also change the set values by following preset ratios to the master.

- Up to 32 controllers with 16 groups can be configured.

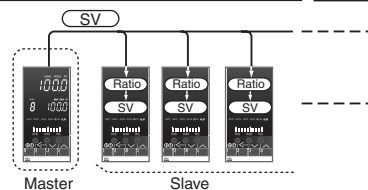

Cascade Control

It is effective when a thermal time-delay exists between the heat source and a control point. A maximum of 30 slave controllers can be connected to one master controller.

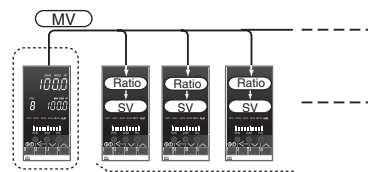

Group RUN/STOP Function

When RUN/STOP mode is changed on one controller in a group, the mode of all the other controllers in the same group will be also automatically changed.

- Up to 32 controllers with 16 groups can be configured.

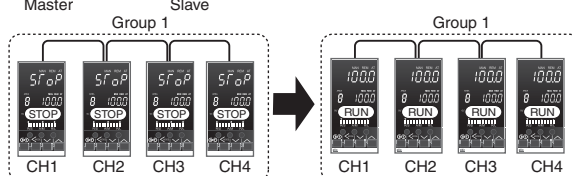

(Note) Time lag among controllers caused by inter-controller communication is (Max.70ms) x (number of controllers connected). Please consider the time lag of inter-controller communication for high-speed process control in which process changes rapidly.

Features

Brilliant II PID Control

● Selectable PID control algorithm

PID control algorithm is selectable in the FB Series to achieve the most precise control for various applications.

PV Derivative PID : suitable for fixed setpoint control (Factory setting)

Deviation Derivative PID : suitable for ramp control using ramp-to-setpoint function and cascade control.

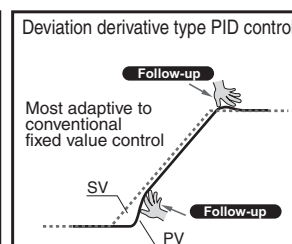
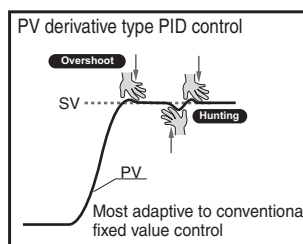

● Selectable sampling time among 50ms, 100ms, and 250ms.

Selectable sampling time makes the FB Series suitable for any application ranging from pressure control requiring fast response to precise control requiring highest resolution. The selections are 100ms (factory setting) usually suitable for most of standard applications, 50ms for fast response applications, and 250ms for precise control requiring high-resolution. The PID parameters can be set in 1/10 unit which supports fast and accurate control. Ramp-to-setpoint and output-change-limiter functions are each settable for UP and DOWN so that a special heater can be controlled precisely.

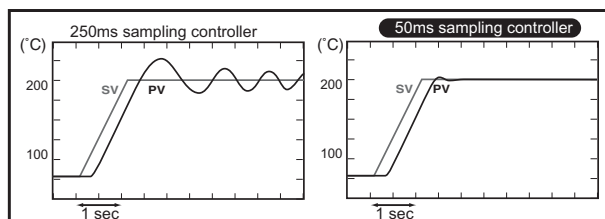

● Advanced Heat/Cool PID algorithm with Undershoot Suppression

Advanced Heat/Cool PID algorithm achieves stable control by the Undershoot Suppression (USS) function, and independent P-I-D settings for both Heat and Cool which are effective for applications with strong cooling gain. Control Response type selection is settable to avoid overshoot at start-up and against external disturbance. The FB Series also offers selection of water cool and air cool PID control algorithm.

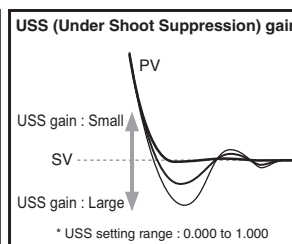
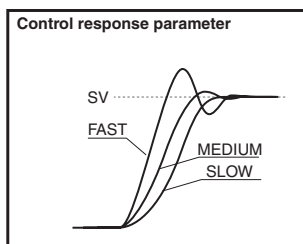

● Configurable control type

The control type is configurable among Heat, Cool, Heat/Cool, and position proportioning.

Autotuning

● Autotuning to calculate optimum PID parameters

The improved Autotuning algorithm calculates optimum PID parameters. For Heat/Cool control, PID parameters for both sides (Heat and Cool) are calculated.

● Start-up tuning to eliminate time for autotuning

Start-up tuning eliminates time required for conventional autotuning as it calculates optimum PID values by temperature characteristics at start up. It is useful in applications which require a long time for conventional autotuning. The timing of activation of start-up tuning can be selected from at power-up, at setpoint change, and at power-up/setpoint change. It is also settable to Only-once or always-ON.

- Startup tuning is not available with Heat/Cool PID control type.
- Validity/invalidity of the startup tuning function can be set.
- Heater power needs to be turned on simultaneously with or before turning on power to the temperature controller.
- If start-up tuning does not calculate suitable PID values due to characteristics of application, use Autotuning function.

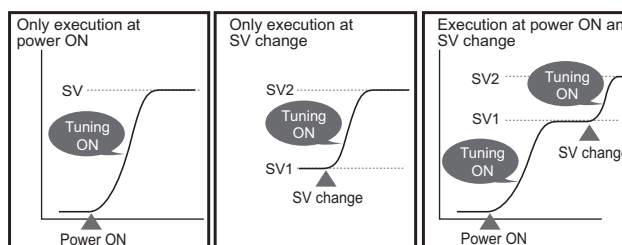

● Output limiters high and low for autotuning

Output limiters high and low for autotuning enables autotuning to be used with any application in which the output has to be within limited range, even during autotuning. High and low are independently settable.

AT function when limiter is not effective. AT function when limiter is effective.

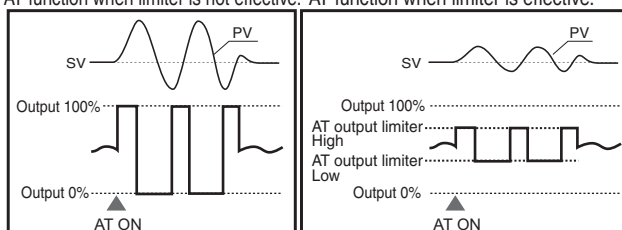

Features

Setup and Data Monitoring

The FB Series has the loader port (provided as standard) to connect to a PC USB port with Windows2000/XP. The standard port allows setup and data logging to be managed by the PC. The FB Series is recognized as an external device on the PC.

● Easy data monitoring/logging with Win-UCI

The Win-UCI can store maximum 8,000 points of data. Data can be exported as an electronic file in CSV format. It has a trend graph function and data monitoring function.

"Win-UCI" software for setup & data logging is free.
Simply download "Win-UCI" from the RKC Instrument website (www.rkcinst.com).

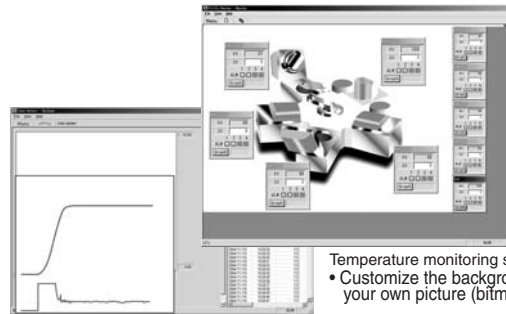
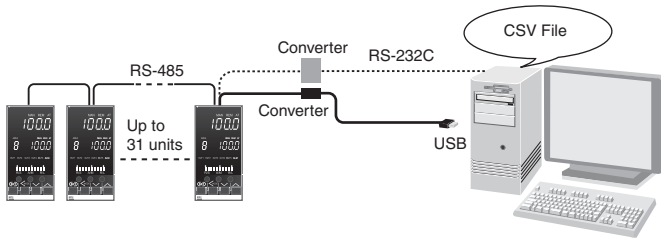

Temperature monitoring screen
• Customize the background with your own picture (bitmap format)

Data logging and trend graph screen

● Easy setup with Win-UCI

Using the Win-UCI, the controller setup and parameter settings can be done from a PC. The parameter settings can be stored on the PC making it easy to copy the same parameters to other FB Series controllers.

- The instrument must have a hardware required for selected functions.



Data setting screen

● No power supply cable necessary at setup

When setting up the FB Series via the loader port, the power can be supplied from the PC via the USB port so no power supply cable is necessary. Just connect the cable to the FB Series and setup is ready to go.

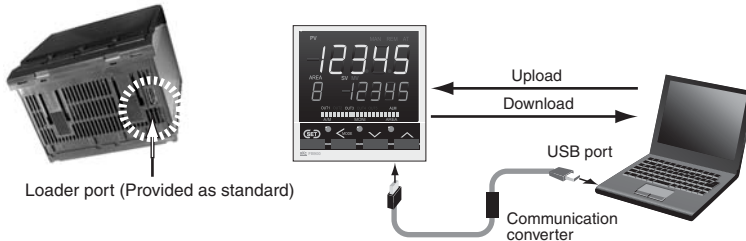

Loader port (Provided as standard)

Communication converter : COM-K

(Unit : mm)

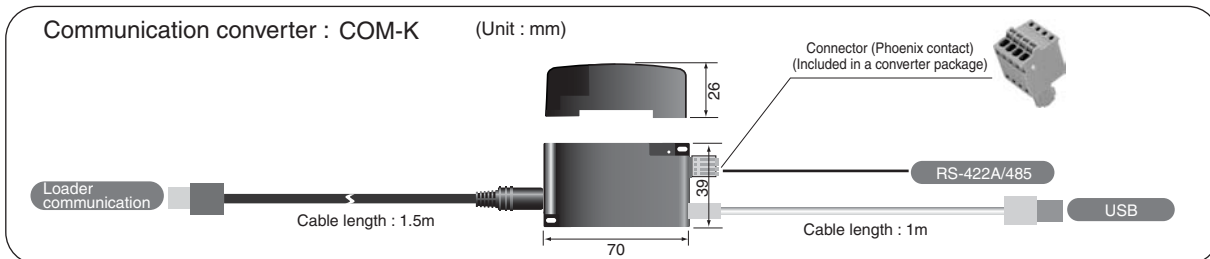

Reinforced Insulation, Lead-free PCBs, Low Power Consumption

● Reinforcement Insulated Power Supply Circuit

Power supply circuit of the FB Series has been designed to be reinforcement insulated. It saves cost to perform basic insulation on the equipment side.

<Requirements for electrical equipment according to safety standards>

The safety standards on electrical equipment (IEC 61010-1 and JISC 1010-1) request that the secondary side of the equipment which may be touched by the operator should be double insulated or reinforcement insulated* from high voltage causing electric shock.

- Insulation safeguarding personnel from electric shock which is equal to double insulation or higher is called "reinforced insulation".

● Lead-free Design complying with EU Directive

The FB Series uses lead-free PCBs complying with EU Directive *.
* WEEE Directive (Waste Electricals/Electrical Equipment Directive) and RoHS Directive (Directive of Restricting the use of Harmful Materials for Electrical Products)

● Low Power Consumption, Low Heat Generation

The power consumption is 30% less than the equivalent model of RKC REX-F900. The saving is 5VA per controller at 240VAC. It also generates less heat and it helps keep temperature low inside the control cabinet.

Features

Open Network Connectivity

The FB Series can be connected to various Open Networks, such as PROFIBUS, DeviceNet, CC-Link, and Ethernet via a gateway. A gateway with the MAPMAN function is available with the FB Series. The MAPMAN function requires no PLC programming and automatically writes process data into the PLC registers and updates parameters continuously.

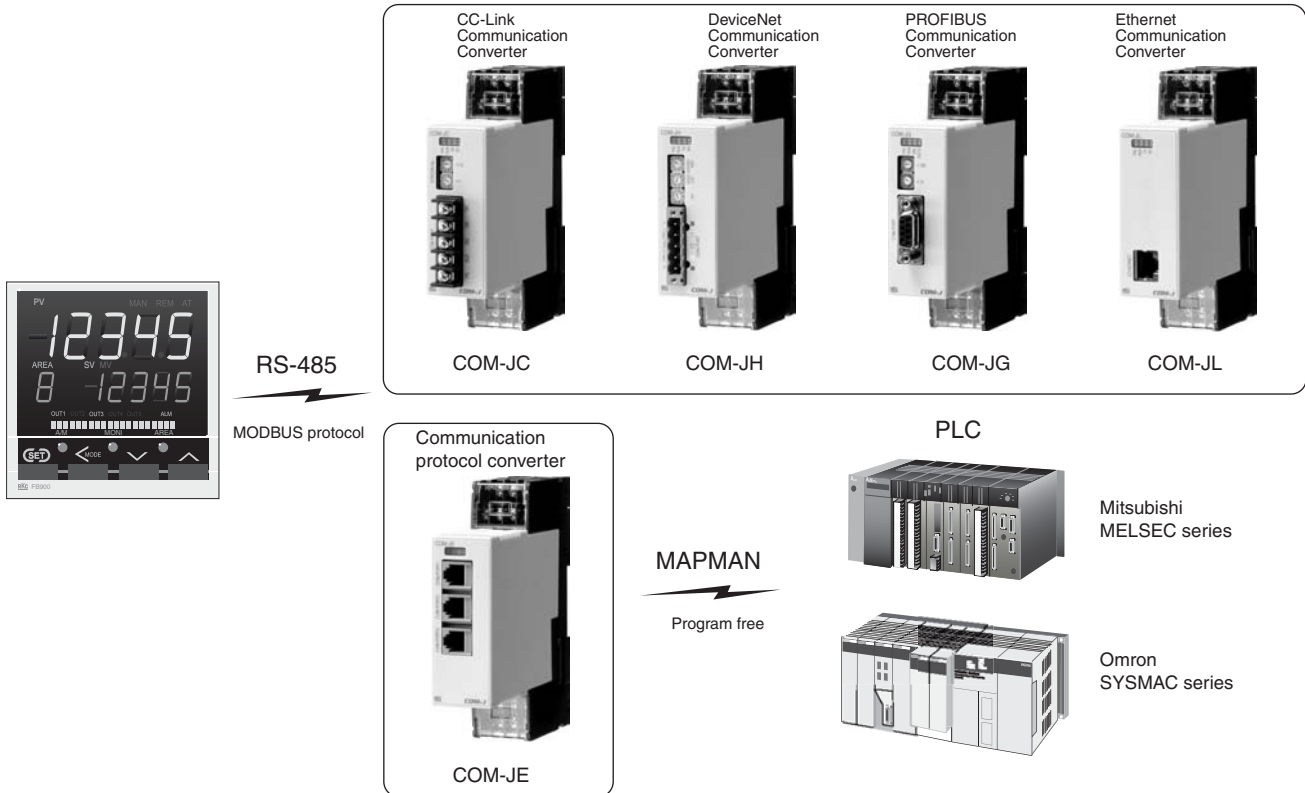



Specifications

Input

Input

- Universal input
- a) Temperature, Current, Low voltage input group
- Thermocouple : K, J, R, S, B, E, T, N (JIS/IEC), PLII (NBS), W5Re/W26Re (ASTM), U, L (DIN)
- Influence of external resistance : Approx. $0.2\mu\text{V}/\Omega$
 - Input break action : Up-scale / Down-scale (Selectable)
- RTD : Pt100 (JIS/IEC), JPt100 (JIS)
- Influence of input lead resistance : Approx. $0.01[\%/\Omega]$ of reading
 - Maximum 10Ω per wire
 - Input break action : Up-scale
- Low voltage : 0 to 1V DC, 0 to 100mV DC, 0 to 10mV DC, -100 to +100mV DC, -10 to +10mV DC
- Input break action : Up-scale / Down-scale (Selectable)
- Current : 4 to 20mA DC, 0 to 20mA DC
- Input break action : Uncertain (indicates a value around 0mA)
- b) High voltage input group
- High voltage : 0 to 5V DC, 1 to 5V DC, 0 to 10V DC, -1 to +1V DC
- Input break action : Uncertain (indicates a value around 0V)

Sampling Time

- 0.1 sec
- 0.05sec or 0.25sec is available.

Input Digital Filter

- 0.1 to 100.0 sec (OFF when 0 is set.)

PV Bias

- span to +span

PV Ratio

- 0.500 to 1.500

Square Root Extraction

- Equation : $PV = \sqrt{(\text{Input value} \times \text{PV ratio} + \text{PV bias})}$
- Low level cut OFF : 0.00 to 25.00% of span

Performance

Measuring Accuracy

- a) Thermocouple
- Type : K, J, T, E, N, PLII, U, L
- Less than -100°C (-148°F) : $\pm 1.0^{\circ}\text{C}$ ($\pm 1.8^{\circ}\text{F}$)
- -100 to 500°C (-148 to 932°F) : $\pm 0.5^{\circ}\text{C}$ ($\pm 0.9^{\circ}\text{F}$)
- More than 500°C (932°F) : $\pm(0.1\%$ of Reading + 1 digit)
- Type : N, S, R, W5Re/W26Re
- Less than 0°C (32°F) : $\pm 2.0^{\circ}\text{C}$ ($\pm 3.6^{\circ}\text{F}$)
- 0 to 1000°C (-148 to 1832°F) : $\pm 1.0^{\circ}\text{C}$ ($\pm 1.8^{\circ}\text{F}$)
- More than 1000°C (1832°F) : $\pm(0.1\%$ of Reading + 1 digit)
- Type : B
- Less than 400°C (752°F) : $\pm 70.0^{\circ}\text{C}$ ($\pm 126^{\circ}\text{F}$)
- 400 to 1000°C (752 to 1832°F) : $\pm 1.4^{\circ}\text{C}$ ($\pm 2.5^{\circ}\text{F}$)
- More than 1000°C (1832°F) : $\pm(0.1\%$ of Reading + 1 digit)
- Cold junction temperature compensation error
- $\pm 1.0^{\circ}\text{C}$ (1.8°F) [at 5 to 40°C (41 to 104°F)]
- Within $\pm 1.5^{\circ}\text{C}$ ($\pm 2.7^{\circ}\text{F}$)
- [Between -10 and 5°C (14 to 41°F), 40 and 50°C (104 to 122°F)]
- b) RTD
- Less than 200°C (392°F) : $\pm 0.2^{\circ}\text{C}$ ($\pm 0.4^{\circ}\text{F}$)
- More than 200°C (392°F) : $\pm(0.1\%$ of Reading + 1 digit)
- c) DC voltage and DC current
- $\pm(0.1\%$ of span)
- Close horizontal mounting error : $\pm 1.5^{\circ}\text{C}$ ($\pm 2.7^{\circ}\text{F}$)

Insulation Resistance

- More than $20\text{M}\Omega$ (500V DC) between measured terminals and ground
- More than $20\text{M}\Omega$ (500V DC) between power terminals and ground

Dielectric Strength

- 1000V AC for one minute between measured terminals and ground

Control

Control Method

- a) Brilliant II PID control
- Available for reverse and direct action.
- b) Brilliant PID control (Heat/Cool type)
- c) Position proportioning control without feedback resistance.
- a), b), c) is selectable.

Autotuning Method

- a) For PID control (Direct action/Reverse action)
- b) For Heat/Cool PID control (For extruder, air cooling type)
- c) For Heat/Cool PID control (For extruder, water cooling type)
- d) For Heat/Cool PID control

Startup tuning

- The condition to activate Startup Tuning is selectable among a) to g)
- a) At power-on, one-time tuning
- b) At SV change, one-time tuning
- c) At power-on and SV change, one-time tuning
- d) At power-on, always on
- e) At SV change, always on
- f) At power-on and SV change, always on
- g) Function off
- (Not available for Heat/Cool PID control type)

Major Setting Range

- Set value : Same as input range.
- Proportional band : 0 to input span (Temperature input)
0.0 to 1000.0% of span (Voltage, Current input)
(ON/OFF control when P = 0)
- Integral time : 0 to 3600sec. or 0.0 to 1999.9sec.
(selectable)
- Derivative time : 0 to 3600sec. or 0.0 to 1999.9sec.
(selectable)
- Cool-side proportional band : 1 to input span (Temperature input)
0.1 to 1000.0% of span (Voltage, Current input)
- Cool-side integral time : 0 to 3600sec. or 0.0 to 1999.9sec.
(selectable)
- Cool-side derivative time : 0 to 3600sec. or 0.0 to 1999.9sec.
(selectable)
- Deadband/Overlap : -span to +span (Temperature input)
-100.0 to +100.0% of span (Voltage, Current input)
- Control response : Slow, Medium, Fast
- Ramp-to-setpoint : 0 to span per Time
(Time is selectable between 1 and 3600 sec)
(Up/Down individual setting)
- Output limiter : -5.0 to +105.0% (High/Low individual setting)
- Cool-side output limiter : -5.0 to +105.0% (High/Low individual setting)
- Output change rate limiter : 0.0 to 100.0%/sec. (Up/Down individual setting)
- Cool-side output change rate limiter : 0.0 to 100.0%/sec. (Up/Down individual setting)
- Proportional cycle time : 0.1 to 100.0 sec.
- Cool-side proportional cycle time : 0.1 to 100.0 sec.
- Manual reset : -100.0 to +100.0%
- Output at control stop mode : -5.0 to 100.5% (Heat/Cool individual setting)

Motor Valve Control (position proportioning control type only)

- Motor time : 5 to 1000 sec. (full open to full close)
- Integral output limiter : OFF, 100.0 to 200.0% of motor time
- Neutral zone : 0.1 to 10.0%
- Differential gap : 0.1 to 5.0%
- Valve action at a stop mode : a) CLOSE : OFF, OPEN : OFF
b) CLOSE : ON, OPEN : OFF
c) CLOSE : OFF, OPEN : ON
- a), b), c) is selectable.

Memory area

- Number of memory area : 8 memory areas
- Setting item : Set value (SV), Proportional band, Integral time, Derivative time, Cool-side proportional band, Cool-side integral time, Cool-side derivative time, Deadband/Overlap, Control response, Manual reset, Ramp-to-setpoint (Up/Down), Event set vale, LBA time, LBA deadband, Soak time : 0 min 0.00 sec to 199 min 59 sec or 0 hr 00 min to 9 hr 59 min
(selectable)
- Linking area number : OFF, 1 to 8

Main Output

Number of Main Output

- Up to 2 points (OUT1, OUT2)

Output Items

- Control output, HBA output, FAIL output

Output Type

- Relay output : Form A contact, 250V AC 3A (resistive load)
- Voltage pulse output : 0/12V DC
(Load resistance : More than 600 Ω)
- Current output : 4 to 20mA DC, 0 to 20mA DC
(Load resistance : Less than 600 Ω)
- Continuous voltage output : 0 to 1V DC, 0 to 5V DC, 1 to 5V DC, 0 to 10V DC
(Load resistance : More than 1k Ω)
- SSR (Triac) output : Rated current : 0.5A
- Open collector output : Load voltage : Less than 30V DC,
Maximum load current : Less than 100mA
(Sink type) ON voltage : Less than 2V DC (at 100mA)



Specifications

Digital Input (DI 1 to 4 : Optional, DI 5 to 7 : Standard)

Number of Inputs
Up to 7 points (DI 1 to 4, DI 5 to 7)

Input Rating
Non-voltage contact input

Functions
DI1 to DI4 : Memory area selection + Area set
DI5 to DI7 : Run/Stop, Remote/Local, Auto/Manual,
Alarm interlock reset,
• Selectable

Remote Setpoint Input (Standard)

Input
DC voltage (Low), Current : 0 to 1V DC, 0 to 100mV DC, 0 to 10mV DC
4 to 20mA DC, 0 to 20mA DC
DC voltage (High) : 0 to 5V DC, 1 to 5V DC, 0 to 10V DC
• PV input and remote setpoint input are not isolated for each other.
• Universal input

Sampling time
0.1 sec (with measuring input sampling time of 0.05 sec)
0.2 sec (with measuring input sampling time of 0.1 sec)
0.5 sec (with measuring input sampling time of 0.25 sec)

Accuracy
0.1% of span

Digital Output (Optional)

Number of Sub Output
Up to 4 points (DO1 to DO4)

Output Items
Event output, Heater break alarm (HBA), FAIL

Output Type
Relay output : Form A contact, 250V AC 1A (resistive load)

Event (Alarm) (Optional)

Number of Event Setting
Up to 4 points (Event 1 to 4)

Alarms
Type : Deviation High, Low, High/Low, Band,
Process High, Low
Set value High, Low
MV value High, Low
Cool side MV value (MV) High, Low
FBR value High, Low
Control Loop Break Alarm (LBA)

Setting range
Deviation : - (Input span) to + (input span)
Differential gap : 0 to input span
Process, Set value : Same as input range
Differential gap : 0 to input span
MV value, FBR value : -5.0 to +105.0%
Control loop break alarm (LBA)
: LBA time : 0 to 7200 sec. (OFF by setting zero)
LBA deadband : 0 to input span

Output
Assignable to digital output (DO1 to 4).

Other Functions
a) Hold/Re-hold action (Valid for deviation/band/process alarm only)
• Hold action is activated at Power-up and STOP to RUN.
Re-hold action is activated at Power-up, STOP to RUN,
and the control set value change.
b) Event action is configurable in case of input abnormality.
c) Energized/de-energized action is configurable.
d) Delay timer : 0.0 to 600.0 sec
e) Interlock (latch) function is configurable.

Heater Break Alarm (Optional)

Number of CT Input
Up to 2 points

CT Input type
CTL-6-P-N (30A), CTL-12-S56-10L-N(100A)
• Selectable

Accuracy
± 5% of input value or ± 2A (whichever is larger)

Display range
0.0 to 100.0A

Output
Assignable to output 2 or digital output (DO2 to 4).

Power feed forward input (Optional)

• Exclusive power feed transformer is required.

Analog Retransmission Output (Optional)

Number of Outputs
1 point

Output types
Measured value (PV), Deviation (DEV), Set value (SV), Manipulated
output value (MV)

Output Signal
Current output : 4 to 20mA DC, 0 to 20mA DC
(Load resistance : Less than 600Ω)
Continuous voltage output : 0 to 1V DC, 0 to 5V DC, 1 to 5V DC, 0 to 10V DC
(Load resistance : More than 1kΩ)

Feedback Resistance (FBR) Input (Optional)

Resistance value
Standard : 100 to 10kΩ (factory default 135Ω)

Sampling time
0.1 sec (with measuring input sampling time of 0.05 sec)
0.2 sec (with measuring input sampling time of 0.1 sec)
0.5 sec (with measuring input sampling time of 0.25 sec)

• Not available with PFF or CT 2 input.

Communications (Optional)

Number of communications : Up to 2 points
Communication method : COM1 : RS-485, RS-232C, RS-422A
COM2 : For Inter-controller communication

Communication speed : 2400, 9600, 19200, 38400 BPS

Protocol : ANSI X3.28(1976) 2.5 A4
MODBUS

Bit format
Start bit : 1
Data bit : 7 or 8 •For MODBUS 8 bit only
Parity bit : Without, Odd or Even
Stop bit : 1 or 2

Maximum connection : RS-485 : 32 units (Including host)
RS-422A : 16 units (Including host)
RS-232C : 1 unit

Communication to Controller : Automatic temperature rise, Cascade control,
Temperature ratio setting, Group STOP/RUN

Waterproof/Dustproof (Standard)

NEMA4X, IP66
• Waterproof/Dustproof protection only effective from the front in panel
mounted installation.

General Specifications

Supply Voltage
a) 90 to 264V AC (Including supply voltage variation)
[Rating : 100 to 240V AC] (50/60Hz selectable)
b) 21.6 to 26.4V AC (Including supply voltage variation)
[Rating : 24V AC] (50/60Hz selectable)
c) 21.6 to 26.4V DC (Ripple rate 10% p-p or less) [Rating:24VDC]

Power Consumption
FB400 : Less than 11.9VA for AC type (at 240V AC)
Less than 8.2VA for 24V AC type
Less than 250mA for 24V DC type
FB900 : Less than 13.0VA for AC type (at 240V AC)
Less than 9.3VA for 24V AC type
Less than 300mA for 24V DC type

Power Failure Effect
A power failure of 20m sec or less will not affect the control action.
If power failure of more than 20m sec occurs, controller will restart with
the state of HOT start 1, HOT start 2 or COLD start (selectable)

Self-Diagnostic Function
Adjustment data check, Back-up check, A/D converter check, etc.

Operating Environments : -10 to 50°C [14 to 122°F]
5 to 95% RH.
Absolute humidity : MAX. W.C 29.3g/m³ dry
air at 101.3kPa.

Memory Backup : Backed up by non-volatile memory (FRAM)
• Data retaining period : Approx. 10 years
• Number of writing : Approx. 1,000,000,000,000 times.
(Depending on storage and operating conditions.)

Net Weight
FB400 : Approx. 230g
FB900 : Approx. 290g

External Dimensions (W x H x D)
FB400 : 48 x 96 x 60mm
FB900 : 96 x 96 x 60mm

Quick Start Code 2

- Quick start code 2 tells the factory to ship with each parameter preset to the values detailed as specified by the customer. Quick start code is not necessarily specified when ordering, unless the preset is requested. These parameters are software selectable items and can be re-programmed in the field via the manual.

Specifications	Initial Setting Code							
	□ □-□ □ □ □-□ □ □							
Output logic selection	See output logic code table. □							
Remote setpoint input signal	0 to 10mV DC	1						
	0 to 100mV DC	2						
	0 to 1V DC	3						
	0 to 5V DC	4						
	0 to 10V DC	5						
	1 to 5V DC	6						
	0 to 20mA DC	7						
	4 to 20mA DC	8						
Event 1 type	Not supplied See event type code table							N □
Event 2 type	Not supplied See event type code table							□ N
Event 3 type	Not supplied See event type code table							□ N
Event 4 type	Not supplied See event type code table LBA (Control loop break alarm)							□ N 5
CT type	No CT1 and CT2 CT1 : CTL-6-P-N, CT2 : No use CT1 : CTL-12-S56-10L-N, CT2 : No use CT1 : CTL-6-P-N, CT2 : CTL-6-P-N CT1 : CTL-12-S56-10L-N, CT2 : CTL-12-S56-10L-N						N P S T U	
Communication 1 protocol	Not supplied ANSI/RKC standard MODBUS							N 1 2

* Please specify "8" when the remote setpoint input signal is not used.

Output Logic Code Table.

Output 1 (OUT 1)	Output 2 (OUT 2)	Digital Output 1 (DO 1)	Digital Output 2 (DO 2)	Digital Output 3 (DO 3)	Digital Output 4 (DO 4)	Code
Control output 1	Control output 2	Event 1	Event 2	Event 3	Event 4	1
Control output 1	Control output 2	Event 1	Event 2	Event 3	HBA	2
Control output 1	Control output 2	Event 1	Event 2	HBA	FAIL (De-energized)	3
Control output 1	Control output 2	Event 1	HBA	Event 3	Event 4	4
Control output 1	HBA	Event 1	Event 2	Event 3	Event 4	5
Control output 1	HBA	Event 1	Event 2	Event 3	FAIL (De-energized)	6
Control output 1	FAIL (De-energized)	Event 1	Event 2	Event 3	Event 4	7

- Energized/De-energized is configurable except for the FAIL output. (Factory default setting: Energized)
- Invalid for a non-existing output/event function. (Caution)
- When used as heating/cooling control/position proportioning control, select any code of 1 to 4.

Event Type Code Table.

Event type	Code
Deviation High	A
Deviation Low	B
Deviation High/Low	C
Band	D
Deviation High with Alarm Hold	E
Deviation Low with Alarm Hold	F
Deviation High/Low with Alarm Hold	G
Process High	H
Process Low	J
Process High with Alarm Hold	K
Process Low with Alarm Hold	L
Deviation High with Alarm Re-Hold	Q
Deviation Low with Alarm Re-Hold	R
Deviation High/Low with Alarm Re-Hold	T
Set value High	V
Set value Low	W
MV value High	1
MV value Low	2
Cool side MV value High	3
Cool side MV value Low	4

Accessory

Current transformer for heater break alarm (HBA) (Sold separately)

Model code
CTL-6-P-N (0 to 30A)
CTL-12-S56-10L-N (0 to 100A)

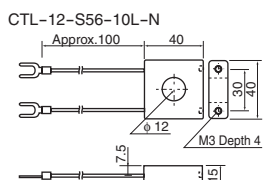
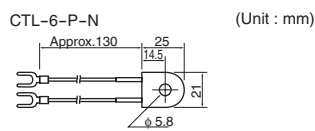

Terminal cover (Sold separately)

Model Code : **KFB400-58**

(FB900 uses 2 unit)

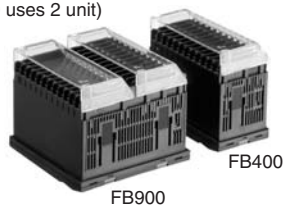

(For Power feed forward input)

* Supplied when power feed forward function is specified. (Unit : mm)

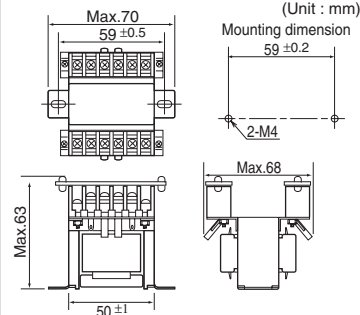

* When ordering transformer for replacement, please specify one of the following model codes.
100 to 120V AC type : PFT-01
200 to 240V AC type : PFT-02

Temperature/Process Controller **FB900/400**

External Dimensions and Rear Terminals

Unit : mm

FB400

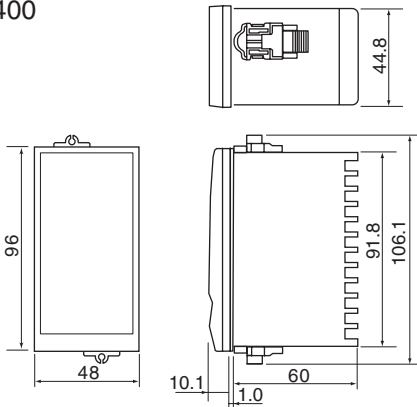

Panel Cutout

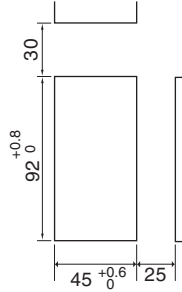

(Panel thickness must be between 1 to 10mm)

(Close horizontal mounting)
* Up to 6 units

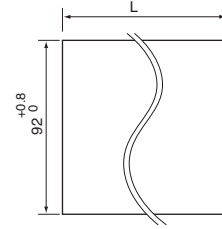

$$L = (96 \times n - 4) + 0.8$$

n : Number of controllers
(2 ≤ n ≤ 6)

FB900

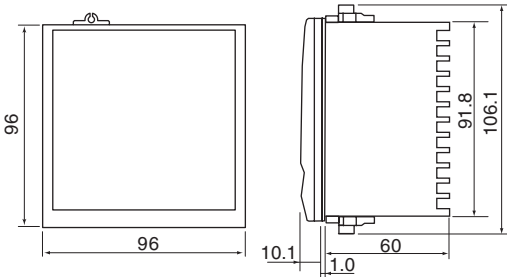

Panel Cutout

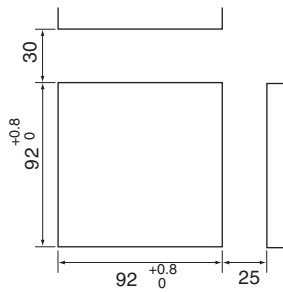

(Panel thickness must be between 1 to 10mm)

(Close horizontal mounting)
* Up to 6 units

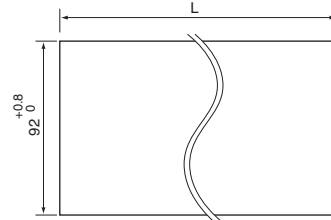

$$L = (48 \times n - 3) + 0.6$$

n : Number of controllers
(2 ≤ n ≤ 6)

• Waterproof/dustproof is not available for close horizontal mounting.

FB400

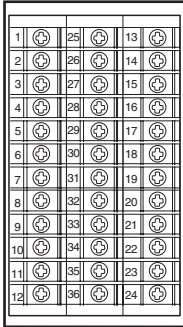

FB900

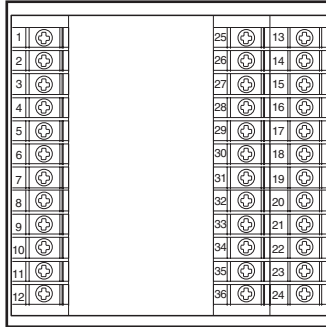

• Use a solderless terminal for screw size M3X6.

No	Description
1	AC 100-240V L DC 24V +
2	24V - N - -
3	COM
4	NO DO4
5	NO DO3
6	COM
7	NO DO2
8	NO DO1
9	NO (1) + -
10	NO (2) - (3)
11	NO (1) + -
12	NO (2) - (3)

No	Description
25	SG - SG - SG
26	SD T/R(A) T(A)
27	(1) RD (2) T/R(B) T(B)
28	R(A) T/R(A)
29	(3) R(B) (4) T/R(B)
30	COM
31	(1) DI 1
32	(2) DI 2
33	(4) DI 3
34	(SET) DI 4
35	+ -
36	AO -

No	Description
13	COM
14	DI 5
15	DI 6
16	DI 7
17	COM (A); OPEN (O); COM (C)
18	CT1 (1); CT2 (2); PFF
19	W (3); CLOSE (C)
20	+ -
21	+ -
22	A B
23	+ -
24	(1) (2) (3)

(*) Optional

CT : Current transformer for heater break alarm
PFF : Power feed forward transformer